

JT EATON™

INDUSTRIAL PROFESSIONAL ONE GALLON SPRAYER Replacement Parts

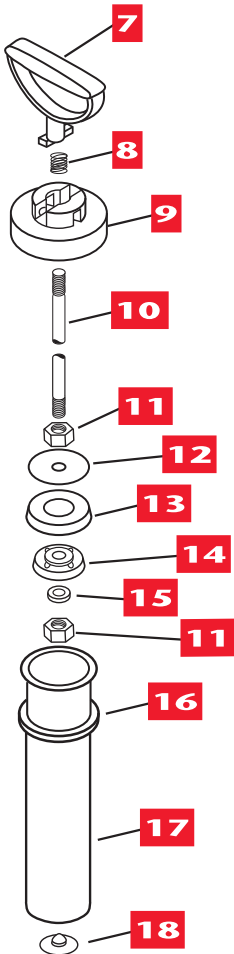
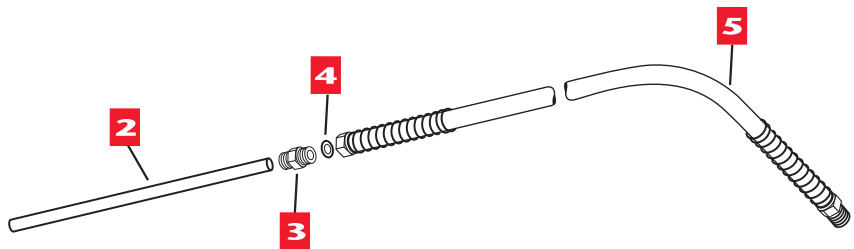

ITEM	JT EATON PART NUMBER	PART DESCRIPTION	INDUSTRY STANDARD
2	872-02	Tube, Siphon (1 Gallon)	OS-297
3	872-03	Adapter, Hose	HA-298
4	872-04	Washer, Hose	D-51-P
5	872-05	Hose, 4 foot, Black (Includes Item 4)	D-50
6	872-06	Pump Assembly (1 Gallon)(Items 7 - 18)	PO-265
7	872-07	Handle, Pump	P-275
8	872-08	Spring, Pump Lock	P-276
9	872-09	Cap, Pump	P-274
10	872-10	Rod, Plunger (1 Gallon)	PO-273
11	872-11	Nut, Plunger (2 Required)	P-269
12	872-12	Plate, Back	P-272
13	872-13	Cup, Polypropylene	NP-277
14	872-14	Plate, Cup Spreader	NP-270
15	872-15	Washer, Lock	P-269A
16	872-16	Gasket, Pump	P-268
17	872-17	Tube, Pump (1 Gallon)	PO-267
18	872-18	Valve, Check (Viton®)	PV-266

6

PUMP ASSEMBLY
(Parts 7-18)

SPRAYER TIP ASSEMBLY

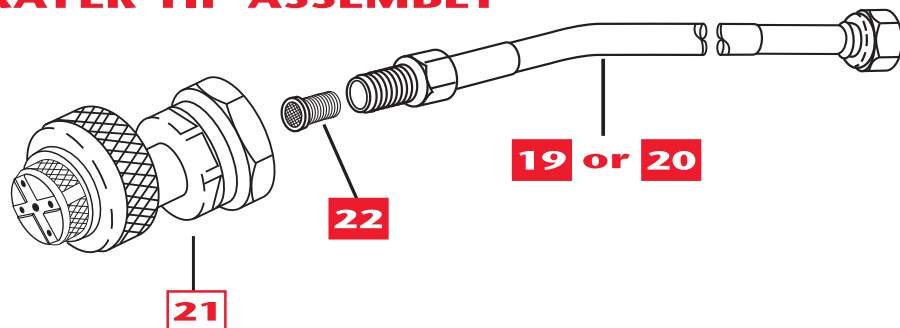

JT EATON ITEM	PART NUMBER	PART DESCRIPTION	INDUSTRY STANDARD
19	872-19	Extension 9 inch Length, Brass	VE-154
20	872-20	Extension 18 inch Length, Brass	VE-155
21	872-21	Standard Tip Assembly (Complete Unit) (Items 33-34-35-36)	5850
21CC	872-21CC	Crack & Crevice Tip Assembly (Complete Unit) (Items 33-34CC-35-36)	5850-CC
22	872-22	Strainer Assembly, Brass with Stainless Steel Screen with CHECK VALVE	

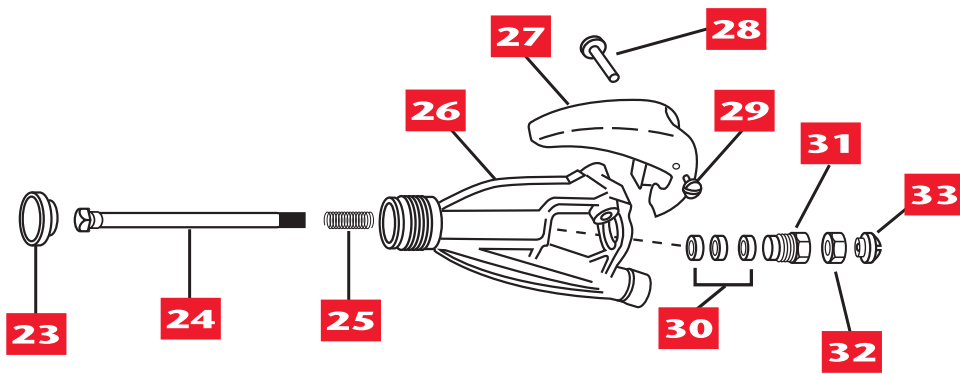

21 STANDARD TIP ASSEMBLY
Parts List (34-37)

CRACK & CREVICE TIP ASSEMBLY
Parts List (34-37)

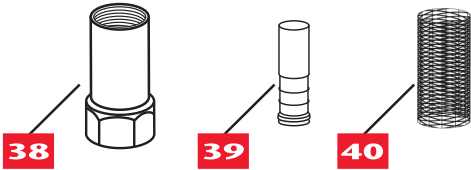
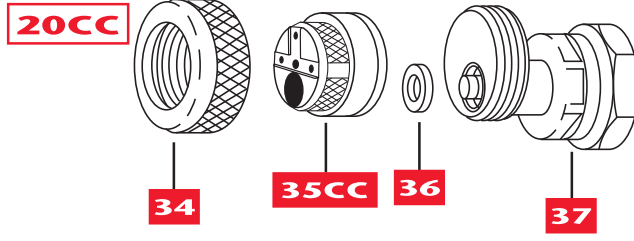
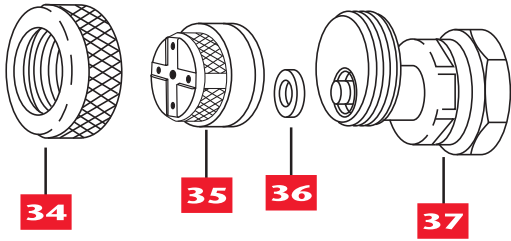

ITEM NO. 872RBK

REBUILDING KIT

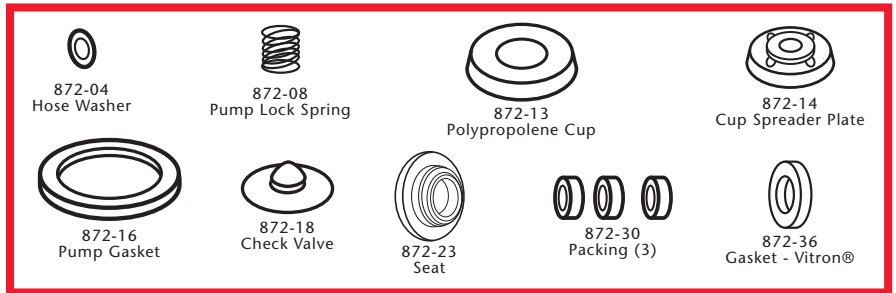

JT EATON			INDUSTRY
ITEM	PART NUMBER	PART DESCRIPTION	STANDARD
23	872-23	Seat	SP-159
24	872-24	Stem & Guide Assembly, Stainless Steel and Brass	
25	872-25	Spring, Type 302 Stainless Steel	
26	872-26	Body, Brass, (For No. AA-31-1/4 F-9526)	
27	872-27	Trigger, Steel, Nickel Plated	VT-140
28	872-28	Screw Housing, Steel, Zinc Plated	SH-142
29	872-29	Screw, Steel, Zinc Plated	TS-141
30	872-30	Packing, (3 Required)	VP-151
31	872-31	Packing Screw, Brass, Electroless Nickel Plated	PN-150-I
32	872-32	Locknut, Brass	LN-149
33	872-33	Screw, Brass	AS-148
34	872-34	Retainer, Brass	4596
35	872-35	Tip, Brass	5800
35CC	872-35CC	Crack & Crevice Tip, Brass	5800-CC
36	872-36	Gasket, Viton®	4190
37	872-37	Body Sub-Assembly (Includes Item No. 36)	9751-M
38	873-01	Strainer Body, Brass	SA-143
39	873-02	Screen Support, Brass	SS-144
40	873-03	Screen, Stainless Steel	MS-145